

## Flow Measurement

### SITRANS F C

#### Transmitter MASS 6000 IP67 compact/remote

##### Overview



MASS 6000 is based on digital signal processing technology – engineered for high performance, fast flow step response, fast batching applications, high immunity against process noise, easy to install, commission and maintain.

The MASS 6000 transmitter delivers true multiparameter measurements i.e. mass flow, volume flow, density, temperature and fraction.

The MASS 6000 IP67 transmitter can be compact mounted on all sensors of type MASS 2100 DI 3 to DI 15, and can be used in remote version for all types of MASS 2100 and FC300 sensors.

##### Note

Due to RoHs directives active from July 22<sup>nd</sup> 2017, MASS 6000 transmitters of any model and variants are not for sale within EU, EU candidate countries, Norway, Switzerland, Iceland, Croatia, and Turkey.

Replacement products: 7ME461.-..., 7ME462.-..., 7ME471.-... and 7ME481.-...

Repair parts for MASS 6000 (all models and variants) are available. See spare part list.

##### Benefits

- Dedicated mass flow chip with the latest ASIC technology
- Fast batching and flow step response with an update rate of true 30 Hz
- Superior noise immunity due to a DFT (Discrete Fourier Transformation) algorithm.
- Front end resolution better than 0.35 ns improves zero point stability and enhances dynamic turn-down ratio on flow and density accuracy.
- Advanced diagnosis and service menu enhances troubleshooting and meter verification.
- Built-in batch controller with compensation and monitoring comprising 2 built-in totalizers
- Multi-parameter outputs, individual configurable for mass flow, volume flow, density, temperature or fraction flow such as Brix or Plato
- Digital input for batch control, remote zero adjust or forced output mode
- All outputs can be forced to preset value for simulation, verification or calibration purposes.
- User-configurable operation menu with password protection
  - 3 lines, 20 characters display in 11 languages
  - Self-explaining error handling/log in text format
  - Keypad can be used for controlling batch as start/stop/hold/reset

- SENSORPROM technology automatically configures transmitter at start-up providing:
  - Factory pre-programming with calibration data, pipe size, sensor type, output settings
  - Any values or settings changed by users are stored automatically
  - Automatically re-programming any new transmitter without loss of accuracy
  - Transmitter replacement in less than 5 minutes.
  - True "plug & play"
- 4-wire Pt1000 temperature measurement ensures optimum accuracy on mass flow, density and fraction flow.
- Fraction flow computation based on a 3rd-order algorithm matching all applications.
- USM II platform enables fitting of add-on bus modules without loss of functionality.
  - All modules can be fitted through true "plug & play"
  - Module and transmitter are automatically configured through the SENSORPROM.
- Installation of the transmitter to the sensor is simple "plug & play" via the sensor pedestal.

##### Application

SITRANS F C mass flowmeters are suitable for all applications within the entire process industry, where there is a demand for accurate flow measurement. The meter is capable of measuring both liquid and gas flow.

The main applications for the MASS 6000 IP67 transmitter can be found in:

- Food and beverage industries
- Pharmaceutical industries
- Automotive industry
- Oil and gas industry
- Power generation and utility industry
- Water and waste water industry

##### Design

The transmitter is designed in an IP67/NEMA 6 compact polyamide enclosure which can be compact mounted on the MASS 2100 sensor range DI 3 to DI 15 (1/8" to 1/2") and remote mounted for the entire sensor series.

The MASS 6000 IP67 is available as standard with 1 current, 1 frequency/pulse and 1 relay output and can be fitted with add-on modules for bus communication.

##### Function

The following functions are available:

- Mass flow rate, volume flow rate, density, temperature, fraction flow
- 1 current output, 1 frequency/pulse output, 1 relay output, 1 digital input
- All outputs can be individually configured with mass, volume, density etc.
- 2 built-in totalizers which can count positive, negative or net
- Low flow cut-off
- Density cut-off or empty pipe cut-off, adjustable
- Flow direction adjustable
- Error system consisting of error-log, error pending menu
- Display of operating time
- Uni/bidirectional flow measurement
- Limit switches with 1 or 2 limits, programmable for flow, density or temperature
- Noise filter setting for optimization of measurement performance under non-ideal application conditions
- Full batch controller
- Automatic zero adjustment menu, with zero point evaluation feed back
- Full service menu for effective and straight forward application and meter troubleshooting

## Technical specifications

<b>Measurement of</b>	Mass flow [kg/s (lb/min)], volume flow [l/s (gpm)], fraction [%], °Brix, density [kg/m <sup>3</sup> , (lb/ft <sup>3</sup> )], temperature [°C (°F)]	<b>Enclosure</b>	
<b>Current output</b>		Material	Fibre glass reinforced polyamide
Current	0 ... 20 mA or 4 ... 20 mA	Rating	IP67/NEMA 6
Load	< 800 Ω	Mechanical load	18 ... 1000 Hz random, 3.17 g RMS, in all directions
Time constant	0 ... 99.9 s adjustable	<b>Supply voltage</b>	
<b>Digital output</b>		24 V version	
Frequency	0 ... 10 kHz, 50 % duty cycle	• Supply	18 ... 30 V DC 20 ... 30 V AC
Time constant	0 ... 99.9 s adjustable	230 V version	
Active	24 V DC, 30 mA, 1 KΩ ≤ R <sub>load</sub> ≤ 10 KΩ, short-circuit-protected	• Supply	87 ... 253 V AC, 50 ... 60 Hz
Passive	3 ... 30 V DC, max. 110 mA, 250 Ω ≤ R <sub>load</sub> ≤ 10 KΩ	<b>Power consumption</b>	
<b>Relay</b>		24 V DC	6 W
Type	Change-over relay	24 V AC	10 VA
Load	42 V/2 A peak	230 V AC	9 VA
Functions	Error level, error number, limit, flow direction	<b>Fuse</b>	
<b>Digital input</b>		230 V version	T 400 mA, T 250 V (IEC 127) - not replaceable by operator
Functionality	11 ... 30 V DC (R <sub>i</sub> = 13.6 kΩ) Start/hold/continue batch, zero point adjust, reset totalizer 1/2, force output, freeze output	24 V version	T 1 A, T 250 V (IEC 127) - not replaceable by operator
<b>Galvanic isolation</b>		<b>EMC performance</b>	
	All inputs and outputs are galva- nically isolated. Isolation voltage: • 500 V to supply • 50 V between outputs	Emission	EN 55011/CISPR-11 (Class A)
<b>Cut-off</b>		Immunity	EN/IEC 61326-1 (Industry)
Low-flow	0 ... 9.9 % of maximum flow	<b>NAMUR</b>	Within the value limits according to "General requirements" with error criteria A in accordance with NE 21
<b>Limit function</b>		<b>Environment</b>	
	Mass flow, volume flow, fraction, density, sensor temperature	Environmental conditions acc. to IEC/EN/UL 61010-1:	• Altitude up to 2000 m • POLLUTION DEGREE 2
<b>Totalizer</b>		<b>Maintenance</b>	The flowmeter has a built-in error log/pending menu which should be inspected on a regular basis.
	Two eight-digit counters for for- ward, net or reverse flow	<b>Cable glands</b>	Two types of cable gland are available in polyamide in the fol- lowing dimensions: M20 or ½" NPT
<b>Display</b>		<b>Note</b>	
	• Background illumination with alphanumeric text, 3 × 20 characters to indicate flow rate, totalized values, settings and faults. Time constant as current output 1 • Reverse flow indicated by nega- tive sign	Due to RoHs directives active from July 22 <sup>nd</sup> 2017, MASS 6000 transmitters of any model and variants are not for sale within EU, EU candidate countries, Norway, Switzerland, Iceland, Croatia, and Turkey. Replacement products: 7ME461.-..., 7ME462.-..., 7ME471.-... and 7ME481.-...	
<b>Zero point adjustment</b>		Repair parts for MASS 6000 (all models and variants) are avail- able. See spare part list.	
	Via keypad or remote via digital input		
<b>Ambient temperature</b>			
Operation	-20 ... +50 °C (-4 ... +122 °F), max. rel. humidity 80 % at 31 °C (87.8 °F) decreasing to 50 % at 40 °C (104 °F) according to IEC/EN/UL 61010-1		
Storage	-40 ... +70 °C (-40 ... +158 °F) (Humidity max. 95 %)		
<b>Communication</b>			
	Add-on modules: HART, PROFIBUS PA and DP, Modbus RTU RS-485, DeviceNet, FOUNDATION Fieldbus H1		

## Flow Measurement

### SITRANS F C

#### Transmitter MASS 6000 IP67 compact/remote

Selection and Ordering data	Article No.
<b>SITRANS F C MASS 6000 transmitter</b> Transmitter for wall mounting with wall mounting bracket, fibre glass reinforced polyamide (1 current output, 1 frq./pulse output, 1 relay output and connection board/PCB) ↗ Click on the Article No. for the online configuration in the PIA Life Cycle Portal.	<b>7ME4110-</b> 
<b>Version</b> Remote IP67/NEMA 6 enclosure	2
<b>Supply voltage</b> 115/230 V AC, 50 ... 60 Hz 24 V AC/DC	1 2
<b>Display/Keypad</b> with display	1
<b>Serial communication</b> No communication HART PROFIBUS PA Profile 3 PROFIBUS DP Profile 3 Modbus RTU RS 485 DeviceNet FOUNDATION Fieldbus H1	A B F G E H J
<b>Cable glands</b> M20 ½" NPT	1 2

#### Operating instructions for SITRANS F C MASS 6000 IP67

Description	Article No.
• English	<b>A5E03071936</b>

All literature is available to download for free, in a range of languages, at [www.siemens.com/processinstrumentation/documentation](http://www.siemens.com/processinstrumentation/documentation)

#### Accessories

Description	Article No.
<b>Cable glands, screwed entries</b> type in polyamide (100 °C (212 °F)) black, 2 pcs. • M20 • ½" NPT	<b>A5E00822490</b> <b>A5E00822501</b> 
<b>Sun lid</b> for MASS 6000 transmitter (Frame and lid)	<b>A5E02328485</b> 

#### Add-on module

Description	Article No.
HART <sup>1)</sup>	<b>FDK:085U0226</b>
PROFIBUS PA Profile 3 <sup>1)</sup>	<b>FDK:085U0236</b>
PROFIBUS DP Profile 3	<b>FDK:085U0237</b>
Modbus RTU RS 485	<b>FDK:085U0234</b>
FOUNDATION Fieldbus H1 <sup>1)</sup>	<b>A5E02054250</b>
DeviceNet	<b>FDK:085U0229</b>



<sup>1)</sup> Modules are rated Ex i when used with MASS 6000 Ex d.

#### Operating instructions for SITRANS F add-on modules



Description	Article No.
HART • English	<b>A5E03089708</b>
PROFIBUS PA/DP • English • German	<b>A5E00726137</b> <b>A5E01026429</b>
Modbus • English • German	<b>A5E00753974</b> <b>A5E03089262</b>
FOUNDATION Fieldbus • English • German	<b>A5E02318728</b> <b>A5E02488856</b>
DeviceNet • English	<b>A5E03089720</b>

All literature is available to download for free, in a range of languages, at [www.siemens.com/processinstrumentation/documentation](http://www.siemens.com/processinstrumentation/documentation)





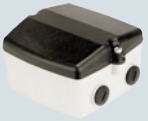



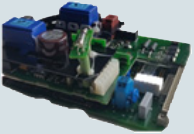

#### Spare parts for compact or remote IP67 version

Description	Article No.
<b>MASS 6000 transmitter IP67/NEMA 6</b> Fibre glass reinforced polyamide and without connection board 1 current output 1 frq./pulse output 1 relay output • 115/230 V AC, 50/60 Hz • 24 V AC/DC	<b>7ME4110-1AA10-1AA0</b> <b>7ME4110-1AA20-1AA0</b> 
<b>Wall mounting unit for IP67/NEMA 6 version</b> with wall bracket, without connection board but with • 4 x M20 cable glands • 4 x ½" NPT cable glands	<b>FDK:085U1018</b> <b>A5E01164211</b> 
<b>Connection board/PCB</b> Supply voltage: 115/230 V/24 V AC/DC	<b>FDK:083H4260</b> 

## Transmitter MASS 6000 IP67 compact/remote

Description	Article No.	
<b>Terminal box kit with</b> <ul style="list-style-type: none"> <li>• M20 cable glands</li> <li>• ½" NPT cable glands</li> </ul> Change from remote to safe area compact mounting of MASS 6000 IP67/NEMA 6 with MASS 2100. The kit consists of a terminal box in polyamide incl. connection board, cable and connector between PCB and sensor pedestal, PCB, seal and screws (4 pcs.) for mounting on sensor. Not approved for hazardous locations	<b>A5E00832338</b> <b>A5E00832342</b>	
<b>Terminal box, in polyamide, inclusive lid</b> <ul style="list-style-type: none"> <li>• M20 cable glands</li> <li>• ½" NPT cable glands</li> </ul> Not approved for hazardous locations	<b>FDK:085U1050</b> <b>FDK:085U1052</b>	
<b>Terminal box – lid in polyamide</b>	<b>FDK:085U1003</b>	
<b>Display and keypad</b> <ul style="list-style-type: none"> <li>• Siemens Front</li> </ul>	<b>FDK:085U1039</b>	

**Add-on spare parts required due to RoHs directives and EoL for EU and EU related countries**

Description	Article No.	
<b>MASS 6000 IP67 Spare part PCB main</b> <ul style="list-style-type: none"> <li>• 230 V</li> </ul>	<b>A5E41718138</b>	
<ul style="list-style-type: none"> <li>• 24 V</li> </ul>	<b>A5E41718346</b>	
<b>MASS 6000 19"/IP20 Spare part PCB main</b> <ul style="list-style-type: none"> <li>• 1 current output 230 V</li> <li>• 3 current outputs 230 V</li> <li>• 1 current output 24V</li> <li>• 3 current outputs 24 V</li> </ul>	<b>A5E43226138</b> <b>A5E43226145</b> <b>A5E43226154</b> <b>A5E43226168</b>	
<b>MASS 6000 19"/IP20 Ex Spare part PCB main</b> <ul style="list-style-type: none"> <li>• 1 current output 230 V</li> <li>• 3 current outputs 230 V</li> <li>• 1 current output 24V</li> <li>• 3 current outputs 24 V</li> </ul>	<b>A5E43226277</b> <b>A5E43226342</b> <b>A5E43226441</b> <b>A5E43226455</b>	
<b>MASS 6000 Ex d, Spare part PCB</b> Stainless steel, without module	<b>FDK:083H3061</b>	
<b>MASS 6000 Ex d, Spare part barriere</b> Stainless steel	<b>A5E41718720</b>	
<b>MASS 6000 19"/IP20, Barriere PCB, Ex</b>	<b>A5E41718669</b>	
<b>MASS 6000 Ex d, Connection board</b> Stainless steel	<b>A5E41718522</b>	
<b>MASS 6000 IP20, Front plate</b> Without display	<b>A5E41718695</b>	
<b>MASS 6000 IP20, Front plate, Ex</b> Without display	<b>A5E41718706</b>	

# Flow Measurement

## SITRANS F C

### Transmitter MASS 6000 IP67 compact/remote

#### Dimensional drawings

##### Compact with MASS 6000 IP67

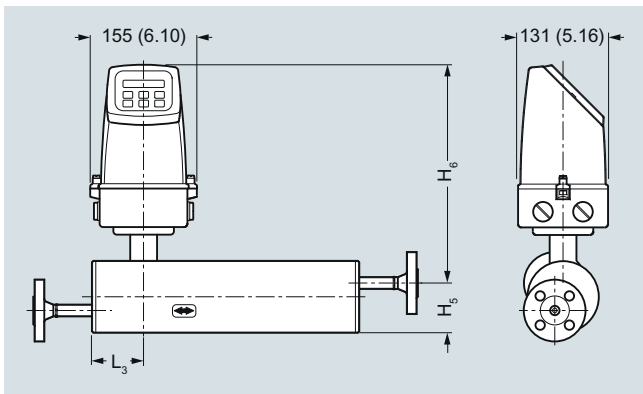

Dimensions in mm (inch)

##### MASS 2100 with MASS 6000 IP67 compact

Sensor size [DI (inch)]	L <sub>3</sub> [mm (inch)]	H <sub>5</sub> [mm (inch)]	H <sub>6</sub> [mm (inch)]	H <sub>5</sub> + H <sub>6</sub> [mm (inch)]
3 (1/8)	75 (2.95)	82 (3.23)	306 (12.04)	388 (15.28)
6 (1/4)	62 (2.44)	72 (2.83)	316 (12.44)	388 (15.28)
15 (1/2)	75 (2.95)	87 (3.43)	326 (12.83)	413 (16.26)

##### Transmitter MASS 6000 IP67 wall mounted

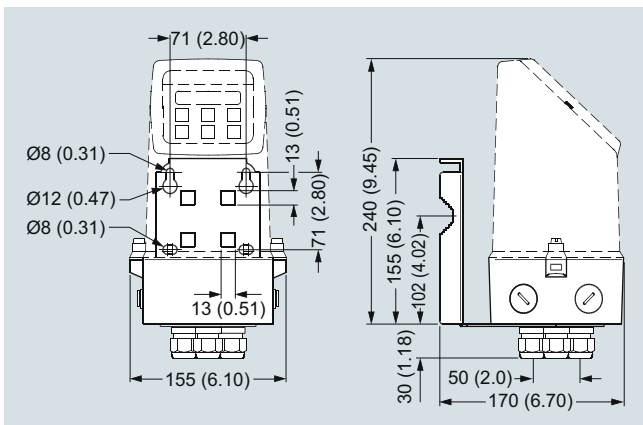

Dimensions in mm (inch)

#### Schematics

##### Electrical connection

###### Grounding

PE must be connected due to safety class 1 power supply.

###### Mechanical counters

When mounting a mechanical counter to terminals 57 and 58 (active output), a 1000 µF min. 35 V electrolytic capacitor must be connected to the terminals 56 and 58. Capacitor + is connected to terminal 56 and capacitor - to terminal 58.

###### Output cables

If long cables are used in a noisy environment, it is recommended to use shielded cables.

